

Magnetic drive pumps

MDH series

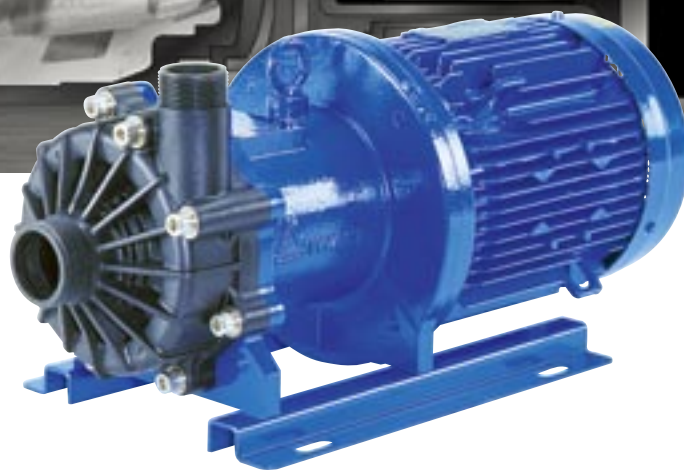

The patented pin point contact system gives dry running capabilities to the pump.

Iwaki's pump technology has produced an innovative magnetic drive pump which incorporates an extremely high resistance to dry running. By employing the newly developed pin point contact system, dry running which was unavailable with previous models is now a feature on the new magnetic drive pump series. The MDH/-F series, with its increased durability and reliability, will further demonstrate its usefulness and convenience as corrosion resistant pumps for the middle flow ranges.

Dry running is possible with a pin point contact system

Up to one hour of continuous dry running is possible due to the pin point contact system which minimizes the heat generated by bearing surfaces during dry running.

Note: Dry running is possible with carbon bearing type (D type) only.

Excellent corrosion resistance

The casings, impeller assembly and magnet capsule of MDH pump are made of polypropylene and those of MDH-F are made of fluoro-resin. Other wet-end parts are made of highly corrosion resistant materials such as carbon, ceramics and the like. The pumps can handle most types of chemicals including acids and alkalis.

Excellent durability

The resin parts for MDH are reinforced with glass fiber and MDH-F is reinforced with carbon fiber for the purpose of enhancing durability. In addition, sufficient consideration was given to the mechanical strength and the safety of the spindle.

Simple structure

The pump unit's simple structure consists of only a few parts. The assembly and disassembly procedures for maintenance purposes are very easy and simple.



MDH-F401

MDH-400

Pin-point contact system

In a no-thrust condition due to dry run, only the impeller thrust surface and spindle fore edge come in contact. The magnet capsule never touches the rear casing.

This "pin point" contact between impeller and spindle thrust surfaces significantly minimizes friction, and therefore heat generation.

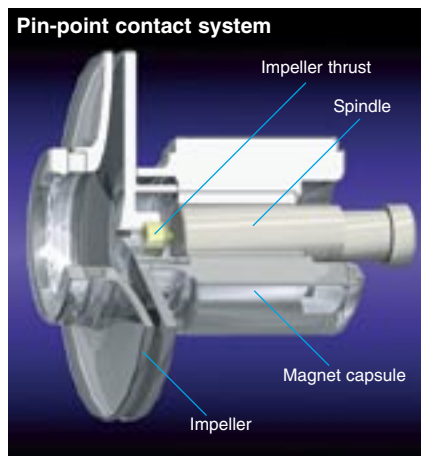

Patents
Japan/Taiwan/U.S.A./Europe/Korea



Actual pumps may differ from the photos.



MDH-425

MDH-F422

Construction and materials

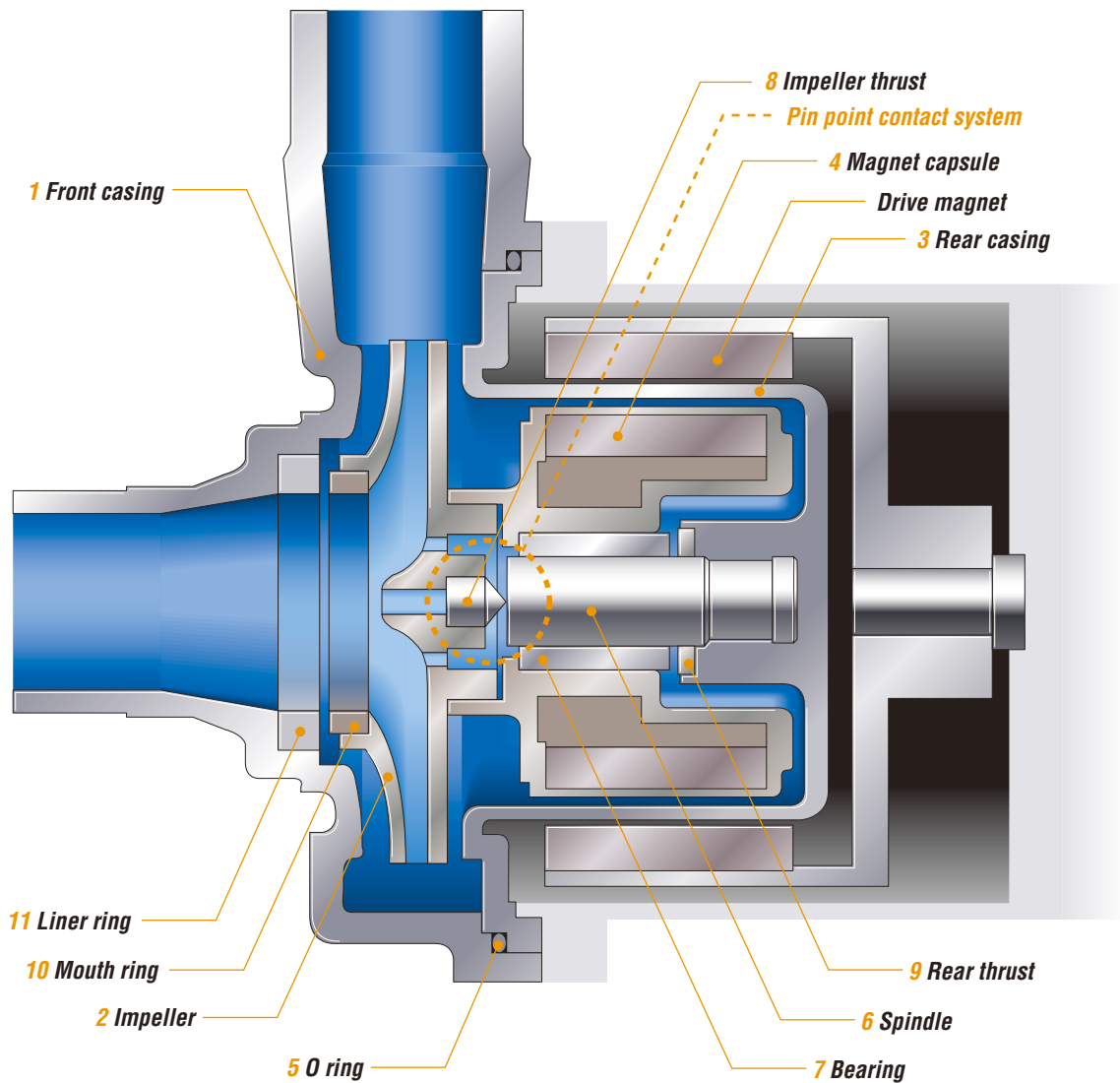

Wet-end materials

Name of part	Model	MDH-400, 401, 422, 423, 425			MDH-F400, 401, 422, 423	
		CV-D	RV-E	FE-D	CFV-D	AAV-E
1 Front casing		GFRPP			CFRETFE	
2 Impeller		GFRPP			CFRETFE	
3 Rear casing		GFRPP			CFRETFE	
4 Magnet capsule		PP			CFRETFE	
5 O ring	Note 1	FKM		EPDM	FKM	
6 Spindle		Alumina ceramic		High purity alumina ceramic		High purity alumina ceramic
7 Bearing		Carbon	PTFE	Carbon	High density carbon	High purity alumina ceramic
8 Impeller thrust		Alumina ceramic		Carbon	High purity alumina ceramic	
9 Rear thrust		High purity alumina ceramic				
10 Mouth ring		PTFE			PTFE	
11 Liner ring		Alumina ceramic		High purity alumina ceramic		Alumina ceramic

Note 1. AFLAS® and EPDM O ring can be included upon request. For more details, inquire at your nearest Iwaki representative or dealer.

Note 2. The material for MDH-F400,401AA is alumina ceramic.

Impeller thrust

When dry running happens, the impeller thrust and the spindle front face come into contact.



Alumina ceramic High-purity Alumina ceramic

Spindle

The spindle is integrally molded with the rear casing to form a cantilever structure. Without any supporting boss in the suction port, the operational efficiency of the pump is increased and the NPSHr is reduced.



High-purity Alumina ceramic Alumina ceramic

Bearing

The bearing is a one-piece and press-fit type.

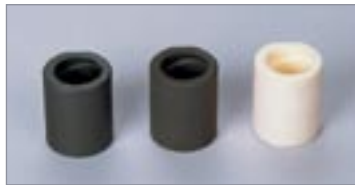

PTFE Carbon High-purity Alumina ceramic

Magnet capsule

High-power magnets are totally encased in the resin to provide sufficient corrosion resistance and torque.



For MDH For MDH-F

Impeller

The impeller is a closed type designed for maximum efficiency. Three different impeller sizes are designed as standard for MDH-F, which adds greater latitude in handling liquids of high specific gravity.



For MDH For MDH-F

Pump identification

MDH-F 422 CFV T - C D

Pump size (Suction side X Discharge side) / Motor output

400: 40(G1 1/2) X 40(G1 1/2) / 0.4kW
401: 40(G1 1/2) X 40(G1 1/2) / 0.75kW
422: 50(G2) X 40(G1 1/2) / 1.5kW
423: 50(G2) X 40(G1 1/2) / 2.2kW
425: 50(G2) X 40(G1 1/2) / 3.7kW

Series symbol

MDH: Casing material-GFRPP
MDH-F: Casing material-CFRETPE

Material of parts

MDH: (Bearing/Spindle/O ring)
CV: Carbon/Alumina ceramic/FKM
RV: PTFE/Alumina ceramic/FKM
FE: Carbon/High purity alumina ceramic/EPDM
MDH-F: (Bearing/Spindle/O ring)
CFV: High-density carbon/High-purity alumina ceramic/FKM
AAV: Alumina ceramic/Alumina ceramic/FKM (For 400 and 401 types)
 : High-purity alumina ceramic/High-purity alumina ceramic/FKM (For 422 and 423 types)

Impeller symbol

MDH
5: 50Hz, **6:** 60Hz
MDH-F
T, V, W: For 50Hz
X, Y, Z: For 60Hz

Pin point contact system

D: Dry running operation for one hour is permissible.
 (MDH: CV type only, MDH-F: CFV type only)
E: Dry run is not possible.

Type of motor

No symbol: TEFC, indoor type
C: TEFC, outdoor type
A: Increased safety type (422 and 423 types do not have increased safety types)

Specifications

Model	Nominal bore size Suction X Discharge	Impeller size	Specific gravity limit	Min. capacity - Max. Head L/min - m		Standard capacity L/min - m		Max. capacity L/min		Motor output kW
				50Hz	60Hz	50Hz	60Hz	50Hz	60Hz	
MDH-400	G 1 1/2 X G 1 1/2 (40 X 40)	5/6	1.0	10 - 12.5	10 - 11.5	150 - 8.5	150 - 8.5	280	280	0.4 2P
MDH-401			1.0	10 - 18.0	10 - 18.0	200 - 12.0	200 - 12.0	330	320	0.75 2P
MDH-422	G 2 X G 1 1/2 (50 X 40)		1.2	20 - 23.0	20 - 22.0	200 - 18.5	200 - 18.5	400	400	1.5 2P
MDH-423				20 - 24.0	20 - 22.5	300 - 20.5	300 - 19.0	500	500	2.2 2P
MDH-425			1.0	50 - 29.0	50 - 31.0	400 - 25.5	400 - 26.5	600	600	3.7 2P
MDH-F400	G 1 1/2 X G 1 1/2 (40 X 40)	T/X	1.2	10 - 11.0	10 - 10.0	150 - 8.0	150 - 7.0	280	250	0.4 2P
		V/Y	1.5	10 - 8.1	10 - 7.5	150 - 6.5	150 - 5.0	230	220	
		W/Z	2.0	10 - 6.3	10 - 5.5	150 - 4.0	150 - 3.0	210	185	
MDH-F401	G 1 1/2 X G 1 1/2 (40 X 40)	T/X	1.2	10 - 16.0	10 - 15.0	200 - 9.5	200 - 9.5	320	310	0.75 2P
		V/Y	1.5	10 - 13.2	10 - 12.0	200 - 8.0	200 - 6.5	280	280	
		W/Z	2.0	10 - 9.0	10 - 9.0	200 - 5.0	200 - 3.5	250	230	
MDH-F422	G 2 X G 1 1/2 (50 X 40)	T/X	1.2	20 - 23.0	20 - 23.0	200 - 17.5	200 - 17.0	400	360	1.5 2P
		V/Y	1.5	20 - 18.0	20 - 18.0	200 - 15.0	200 - 13.5	380	360	
		W/Z	2.0	20 - 12.5	20 - 12.5	200 - 10.0	200 - 9.5	370	340	
MDH-F423	G 2 X G 1 1/2 (50 X 40)	T/X	1.2	20 - 24.0	20 - 22.0	300 - 19.5	300 - 19.0	500	500	2.2 2P
		V/Y	1.5	20 - 19.0	20 - 18.0	300 - 15.5	300 - 14.5	500	500	
		W/Z	2.0	20 - 15.0	20 - 14.0	300 - 11.5	300 - 10.5	470	460	

• The specific gravity limit indicated above is the value at the max. shaft power level and the liquid viscosity of 1 mPa • s(1cP). • Liquid temperature range : 0 to 80°C • Slurry : Inquire of your nearest Iwaki representative or dealer. • Flange type is available on request. Nominal size(mm) is shown in ().

Performance curves

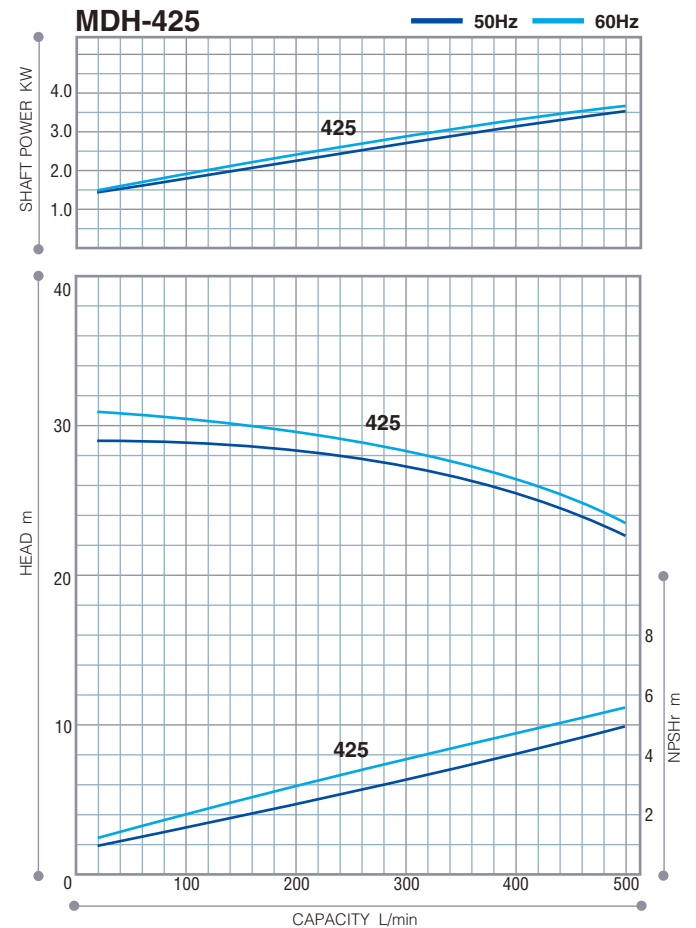
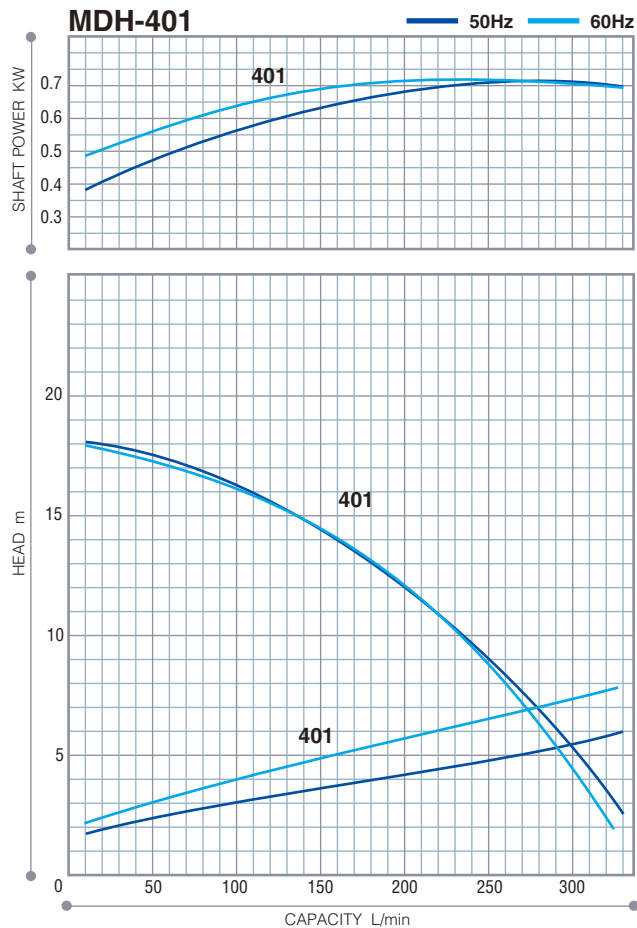
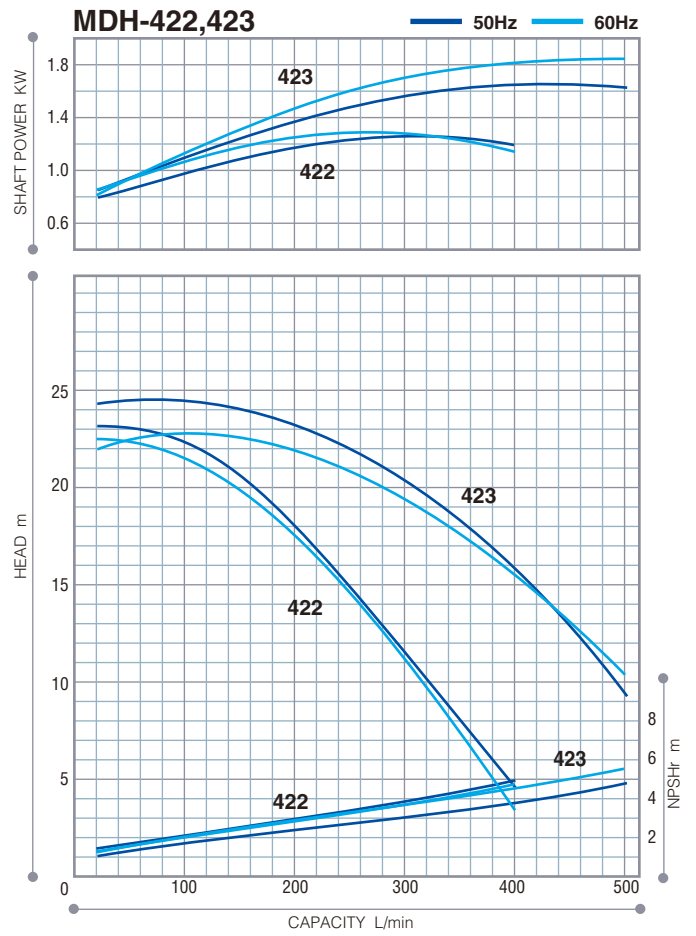
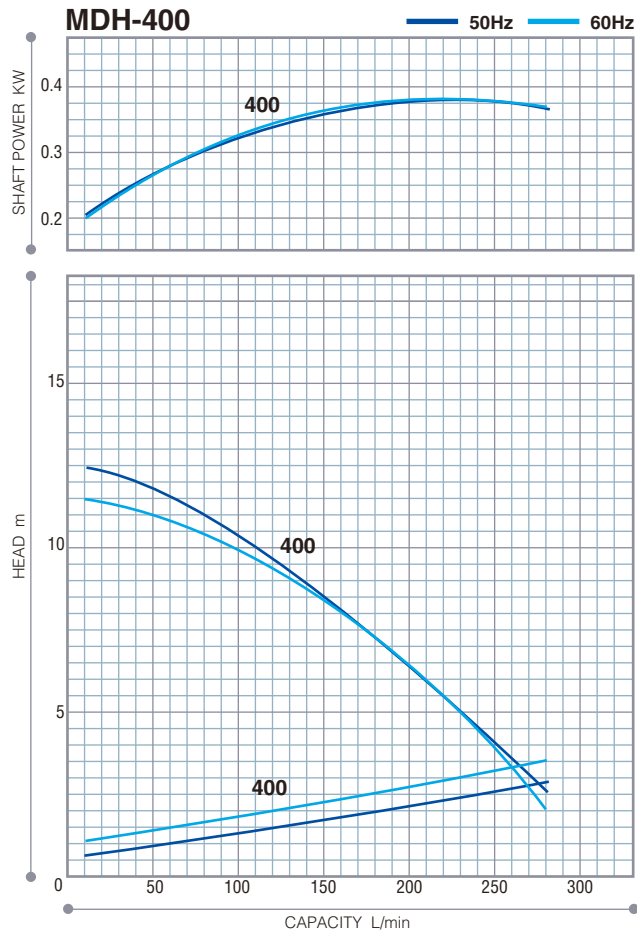

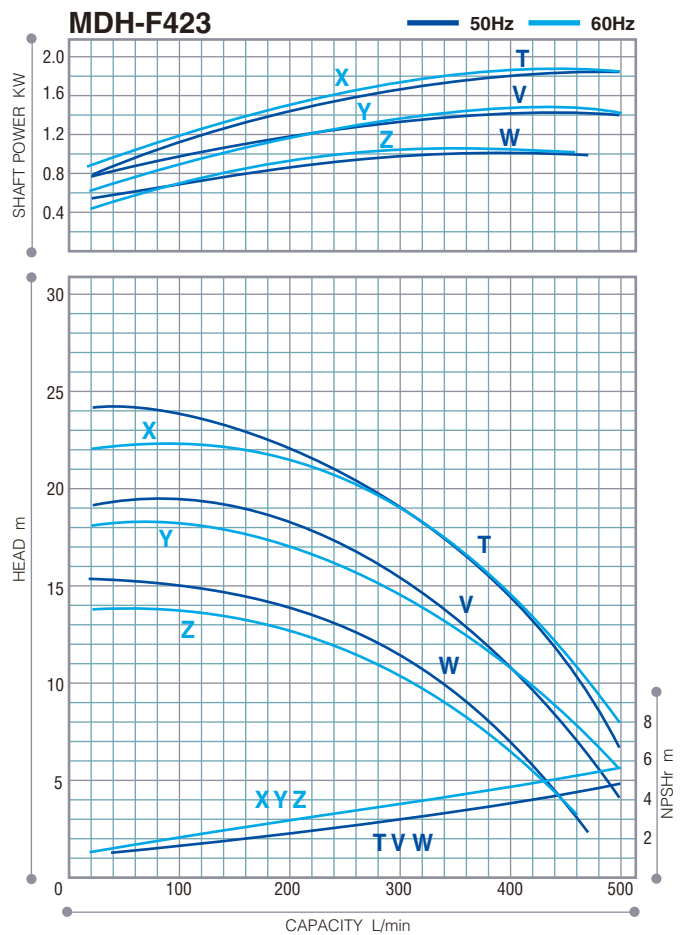
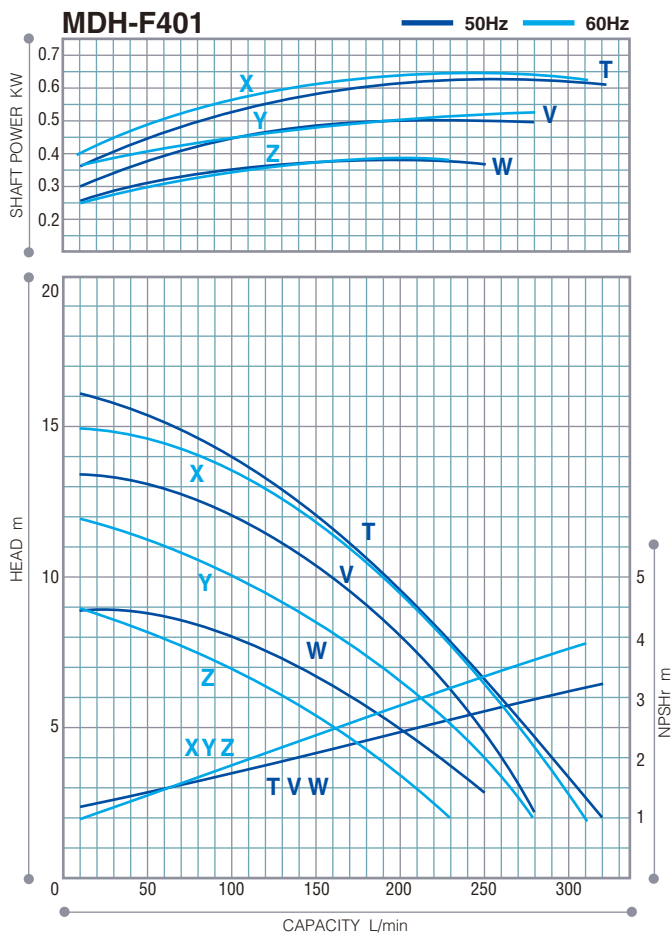
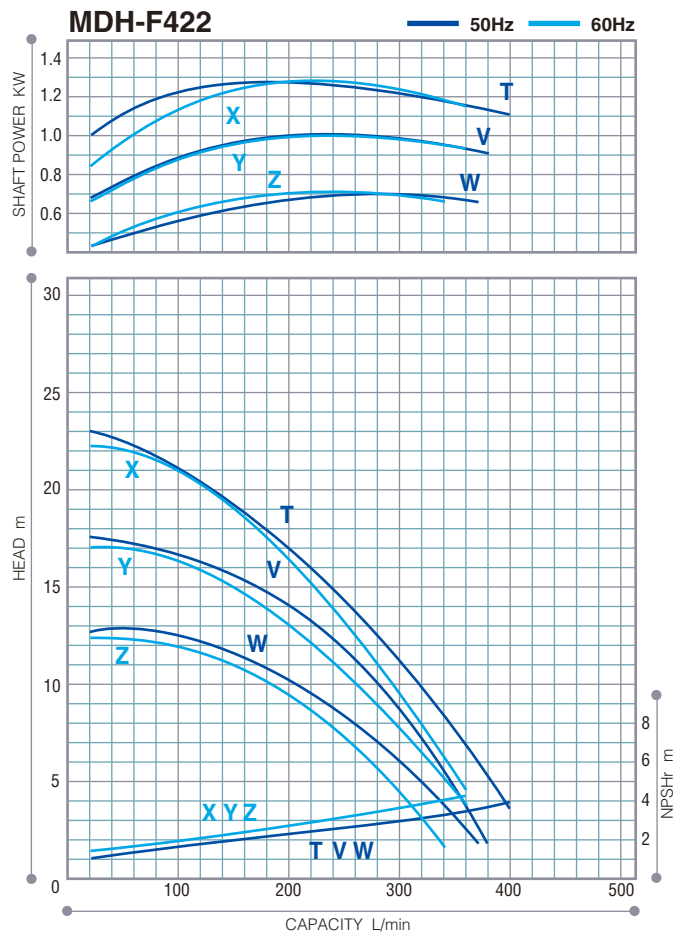
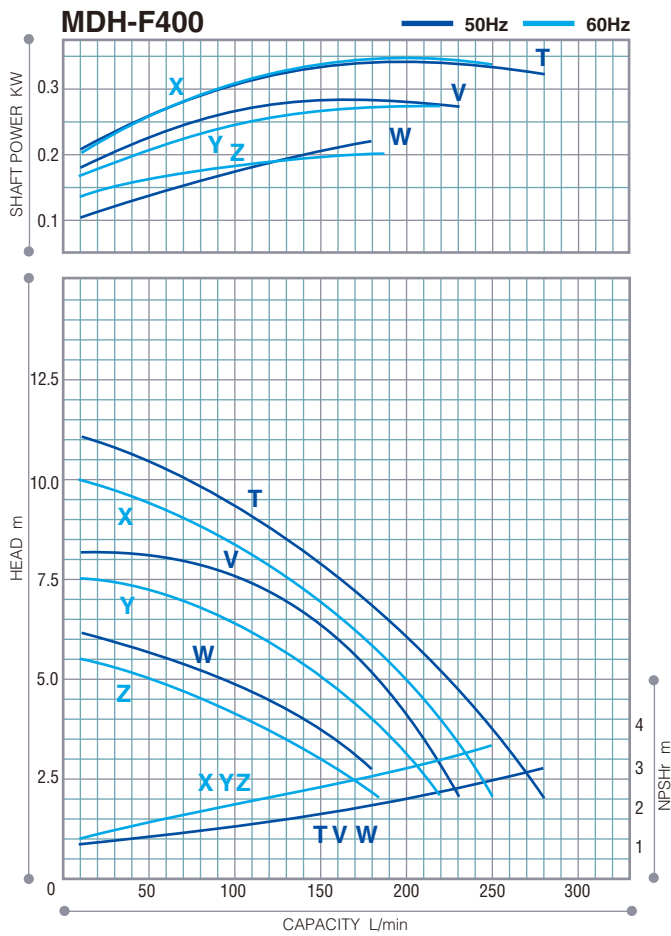

Dimensions in mm

400, 401 type

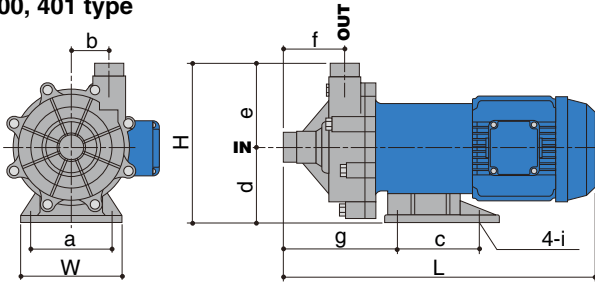

L = The dimension with IWAKI original motor.

Model	W	H	L	a	b	c	d	e	f	g	i
MDH/-F-400	140	210	388	110	51	98	95	115	81	136	O.D.12
MDH/-F-401	160	248	482	130	57.5	130	115	133	97.5	178	O.D.12

422, 423, 425 type

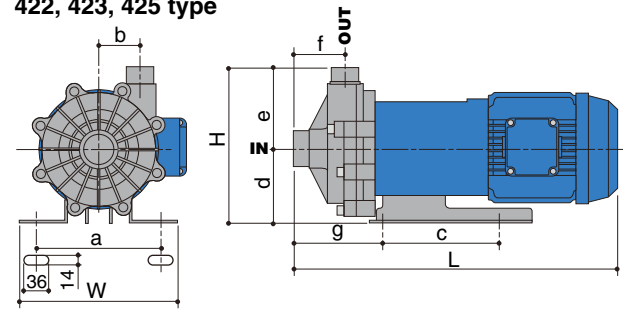

L = The dimension with IWAKI original motor.

Model	W	H	L	a	b	c	d	e	f	g
MDH/-F-422	260	249	533	208	65	200	115	134	83	148
MDH/-F-423	260	249	533	208	65	200	115	134	83	148
MDH-425	260	269	601	230	65	261	135	134	83	150

Base for MDH-425 differs from the illustration above.

Optional accessories

Iwaki dry running protector DR series

Model DR is electric current sensing type dry running protector. It detects the decreased load current (lower limit) to stop the pump when it runs dry or runs with air sucking in. It can detect over-load, too.

Specification

Model	DR-10	DR-20
Motor power	200 to 240V	380 to 440V
Applied motor	0.4 to 7.5kW	0.75 to 15kW
Power	100V ±10% single phase	200 to 240V ±10% single phase
45-65Hz	Input	3.5W
Detective current	0.5 to 32.0A	
Current transformer(CT)	Built-in	
Current range	Auto	4.4/17.6/32A
	Manual	2.2/4.4/8.8/11/17.6/26.4/32A
Ambient	Temperature: 0 to 40°C Humidity: RH40 to 85%	
Outer dimension	D80 X W153 X H122	



DR-20

- Current figure to be set is indicated on LCD.
- Both top/bottom figures can be set.
Top: Over-load
Bottom: Dry running, air sucking-in operation, operation with suction side closed
- Built-in current transformer
- DIN rail mounting

Self-priming tank

A PVC self-priming tank is available as an option. Priming is not necessary once liquid is fed into the tank. Three sizes are available, based on the pump selection.



Specifications

Model	Applicable pumps	Connection port size INXOUT	Priming height	Suction pipe length
SC-400V	MDH/-F-400	40AX40A	Max. 2.5m	Max. 3.8m
SC-401V	MDH/-F-401			
SC-412V	MDH/-F422/423 & MDH-425	50AX50A		

The self-priming height and suction pipe length differ with the piping conditions. Contact Iwaki or your dealer for details.

MD-100R-FL type

The MD-100R-FL uses a flange connection with the small magnetic drive MD pump series. The pump design is similar to that of the MDH and MDH-F series. Since it is sealless, operation is free of leakage. The series can be used in a wide range of applications such as a system component or a stand alone unit.



- Max. capacity: 120/135L/min (50/60Hz)
- Max. Head: 8.5/11.9m (50/60Hz)
- Connection port: 25A X 25A (Suction X Discharge)
- Motor: Single phase AC100, 115, 200 or 220/240V
Three phase AC200, 220/380 or 400/440V

www.iwaki pumps.jp

IWAKI CO.,LTD. 6-6 Kanda-Sudacho 2-chome Chiyoda-ku Tokyo 101-8558 Japan TEL : (81)3 3254 2935 FAX : 3 3252 8892

EUROPE / U.S.A.

European office	: IWAKI Europe GmbH	TEL: (49)2154 9254 0	FAX: 2154 9254 48
Austria	: IWAKI (Austria) GmbH	TEL: (41)26 674 93 00	FAX: 26 674 93 02
Belgium	: IWAKI Belgium N.V.	TEL: (32)13 67 02 00	FAX: 13 67 20 30
Denmark	: IWAKI Nordic A/S	TEL: (45)48 24 2345	FAX: 48 24 2346
Finland	: IWAKI Suomi Oy	TEL: (358)9 2745810	FAX: 9 2742715
France	: IWAKI France S.A.	TEL: (33)1 69 63 33 70	FAX: 1 64 49 92 73
Germany	: IWAKI Europe GmbH	TEL: (49)2154 9254 50	FAX: 2154 9254 55
Holland	: IWAKI Holland B.V.	TEL: (31)297 241121	FAX: 297 273902
Italy	: IWAKI Italia S.R.L.	TEL: (39)02 990 3931	FAX: 02 990 42888
Norway	: IWAKI Norge AS	TEL: (47)66 81 16 60	FAX: 66 81 16 61
Spain	: IWAKI Iberica Pumps, S.A.	TEL: (34)943 630030	FAX: 943 628799
Sweden	: IWAKI Sverige AB	TEL: (46)8 511 72900	FAX: 8 511 72922
Switzerland	: IWAKI (Schweiz) AG	TEL: (41)26 674 93 00	FAX: 26 674 93 02
U.K.	: IWAKI Pumps (UK) Ltd.	TEL: (44)1743 231363	FAX: 1743 366507
U.S.A.	: IWAKI America Inc.	TEL: (1)508 429 1440	FAX: 508 429 1386

ASIA / OCEANIA

Australia	: IWAKI Pumps Australia Pty Ltd.	TEL: (61)2 9899 2411	FAX : 2 9899 2421
China			()Country codes
Hong Kong	: IWAKI Pumps Co., Ltd.	TEL: (852)2607 1168	FAX: 2607 1000
Shanghai	: IWAKI Pumps (Shanghai) Co., Ltd.	TEL: (86)21 6272 7502	FAX: 21 6272 6929
Guangzhou	: GFTZ IWAKI Engineering & Trading Co., Ltd.	TEL: (86)20 8435 0603	FAX: 20 8435 9181
Beijing	: GFTZ Iwaki Engineering & Trading Co., Ltd. (Beijing office)	TEL: (86)10 6442 7713	FAX: 10 6442 7712
Korea	: IWAKI Korea Co., Ltd.	TEL: (82)2 2630 4800	FAX: 2 2630 4801
Malaysia	: IWAKI Sdn. Bhd.	TEL: (60)3 7803 8807	FAX: 3 7803 4800
Singapore	: IWAKI Singapore Pte Ltd.	TEL: (65)6316 2028	FAX: 6316 3221
Indonesia	: IWAKI Singapore (Indonesia Branch)	TEL: (62)21 6906606	FAX: 21 6906612
Taiwan	: IWAKI Pumps Taiwan Co., Ltd.	TEL: (886)2 8227 6900	FAX: 2 8227 6818
Thailand	: IWAKI (Thailand) Co., Ltd.	TEL: (66)2 322 2471	FAX: 2 322 2477
Vietnam	: IWAKI Pumps Vietnam Co., Ltd.	TEL: (84)613 933456	FAX: 613 933399

! Caution for safety use: Before use of pump, read instruction manual carefully to use the product correctly.
Actual pumps may differ from the photos. Specifications and dimensions are subject to change without prior notice. For further details please contact us.